

# TC KEG SERIES

## PRODUCT SHEET

### TC KEG SERIES

The refrigerators are equipped with plastic covered metal sheet outside and inside, digital temperature control, dynamic cooling and necessary ventilation for condensation that makes the cooler especially suitable for use even when tightly built in under the counter.

Its advantage is its broad usability: It can be used with 4, 6, 8 David barrels, 1 or 2 pieces of 30 or 50-liter KEG barrels.



#### IMPORTANT FEATURES

- multi-faceted usability
- foamed case, better isolation
- greater stability
- energy-saving fan
- bottom sheet not deform at the barrels in and outload
- removable aggregate – comfortable operation with handles
- flexible service possibility – simple aggregate change



#### TERMOTECHNIKA-CROWN COOL KFT.

BUDAPEST SHOWROOM AND HEADQUARTERS: H-1103 BUDAPEST, KŐÉR U. 3/F  
TELEFON: (+36-1) 260-7126  
[termotechnika@tcbungary.com](mailto:termotechnika@tcbungary.com)

[www.tcbungary.com](http://www.tcbungary.com)



TERMOTECHNIKA  
CROWN COOL  
EUROPEAN ECONOMIC INTEREST GROUP

# TC KEG SERIES

## PRODUCT SHEET

DIMENSIONS	TC 160SDAN	TC KEG-4	TC KEG-6	TC KEG-8
External size (mm)	600x600x860 (H)	880x601x860 (H)	1181x601x860 (H)	1360x601x860 (H)
Internal size (mm)	516x415(297)x706 (H)	498x500x756 (H)	799x500x756 (H)	976x500x756 (H)
Net volume (l)	142	190	300	370
Gross volume (l)	160	216	326	396
Packaging size (mm)		980x700x1000 (H)	1280x700x1000 (H)	1460x700x1000 (H)
Door size (mm)		567x782,5	516,5x782,5 1 pcs 337,5x782,5 1 pcs	1516,5 x 782,5 2 pcs

TECHNICAL SPECIFICATIONS				
Aggregat	Built in	Built in (removable)	Built in (removable)	Built in (removable)
Climate type (SN, N, ST,T)	N	N	N	N
Temperature range (°C)	+2...+12	+2...+12	+2...+12	+2...+12
Temperature Control	digital	digital	digital	digital
Refrigerant	R600a	R600a	R600a	R600a
Rated Voltage / Frequency (V / Hz)	230/50	230/50	230/50	230/50
Input power (W)	122	313	313	313
Cooling capacity(Watt)		650	650	650
Door material	Plastic covered steel	Plastic covered steel	Plastic covered steel	Plastic covered steel
Internal material	Plastic covered steel	Plastic covered steel	Plastic covered steel	Plastic covered steel
Internal colour	grey	grey	grey	grey
External material	Plastic covered steel	Plastic covered steel	Plastic covered steel	Plastic covered steel
External colour	antracit	antracit	antracit	antracit
Type of lighting	horizontal LED	horizontal LED	horizontal LED	horizontal LED

CAPACITY				
David barrel (pcs)	2	4	6	8
30 l barrel (pcs)	1	1	2	2
50 l barrel (pcs)	no	1	2	2
Mixed barrel (pcs)	no	no	2x David, 1x 50 l	4x David, 1x 50 l

ACCESSORIES				
Lock	no	no	no	no

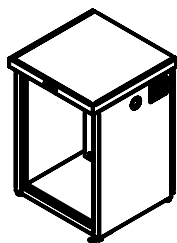

TC160

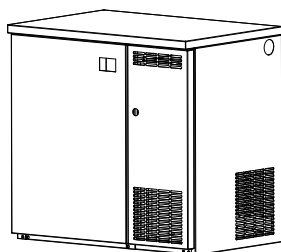

TC KEG-4

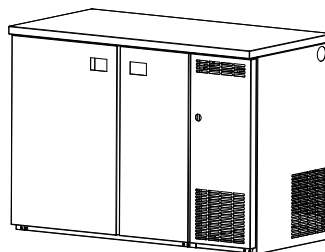

TC KEG-6

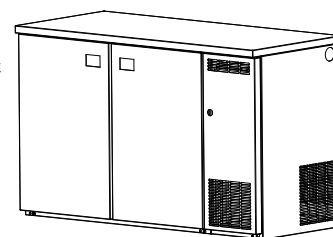

TC KEG-8

### THERMOTECHNIKA-CROWN COOL KFT.

BUDAPEST SHOWROOM AND HEADQUARTERS: H-1103 BUDAPEST, KŐÉR U. 3/F

TELEFON: (+36-1) 260-7126

[thermotechnika@tcbungary.com](mailto:thermotechnika@tcbungary.com)

[www.tcbungary.com](http://www.tcbungary.com)



THERMOTECHNIKA  
CROWN COOL  
EUROPEAN ECONOMIC INTEREST GROUP

# TC KEG SERIES

TC 160SDAN

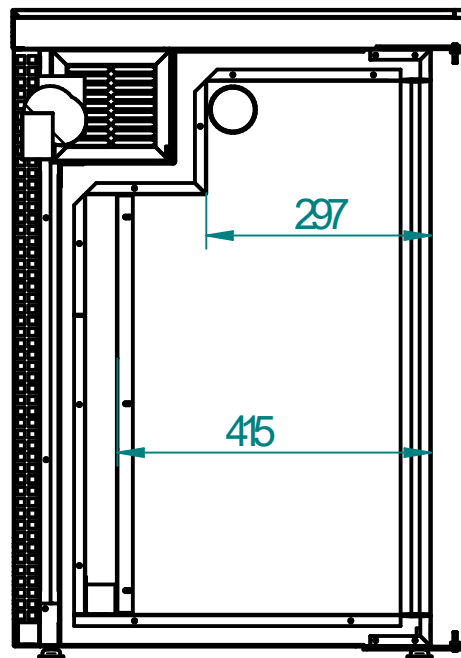
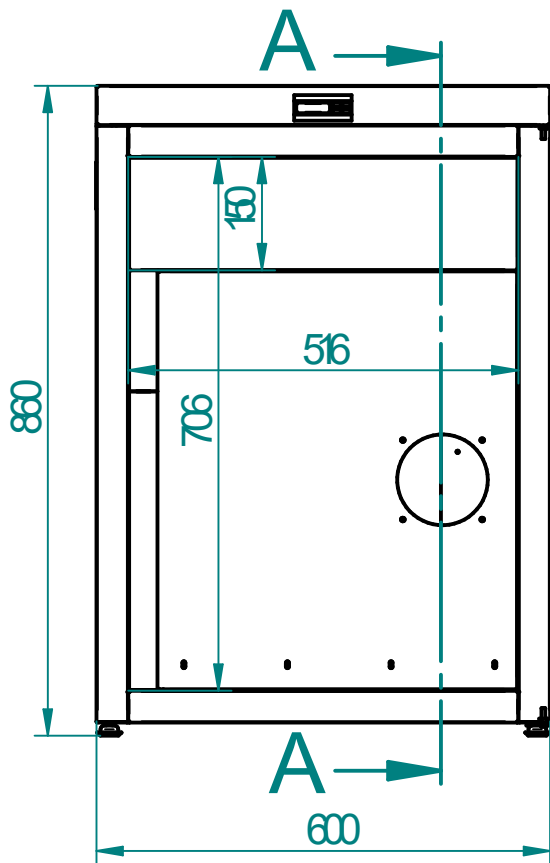

A-A

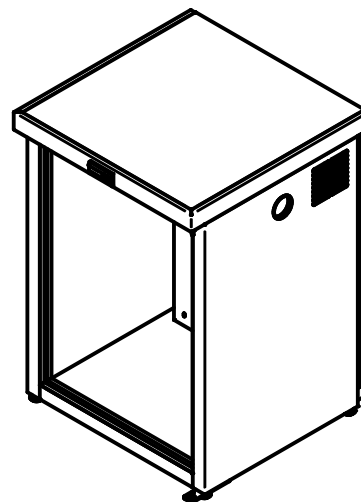
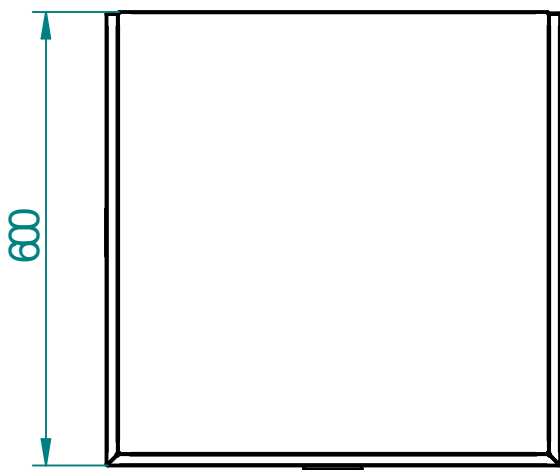

**THERMOTECHNIKA KERESKEDELMI KFT.**

BUDAPEST SHOWROOM AND HEADQUARTERS: H-1103 BUDAPEST, KŐÉR U. 3/F  
TELEFON: (+36-1) 260-7126, 260-7082 • FAX: (+36-1) 433-3851

[thermotechnika@tcbungary.com](mailto:thermotechnika@tcbungary.com)

[www.tcbungary.com](http://www.tcbungary.com)



THERMOTECHNIKA  
CROWN COOL  
EUROPEAN ECONOMIC INTEREST GROUP

# TC KEG SERIES

TC KEG-4

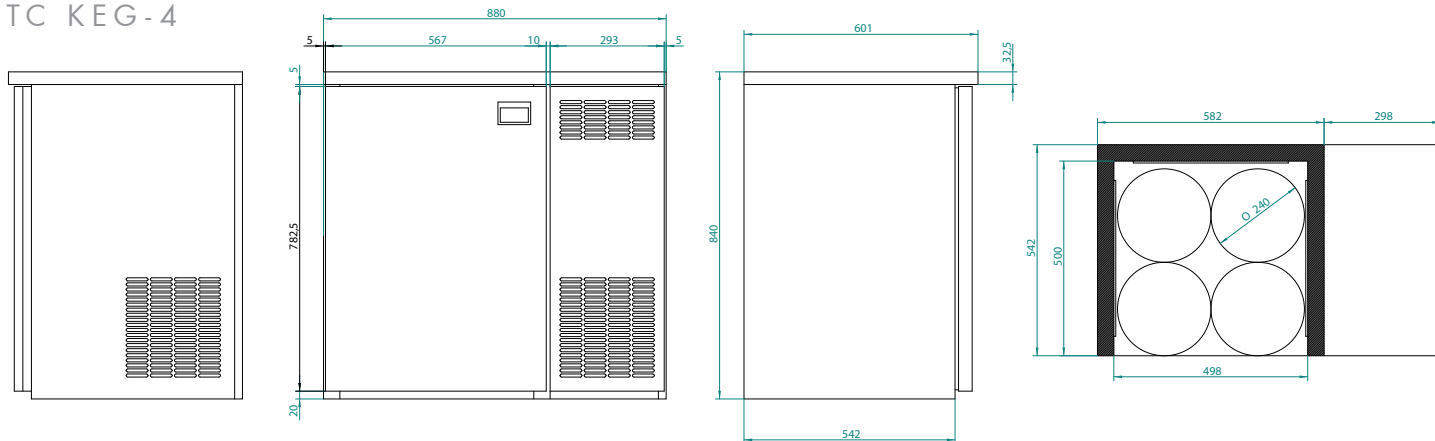

TC KEG-6

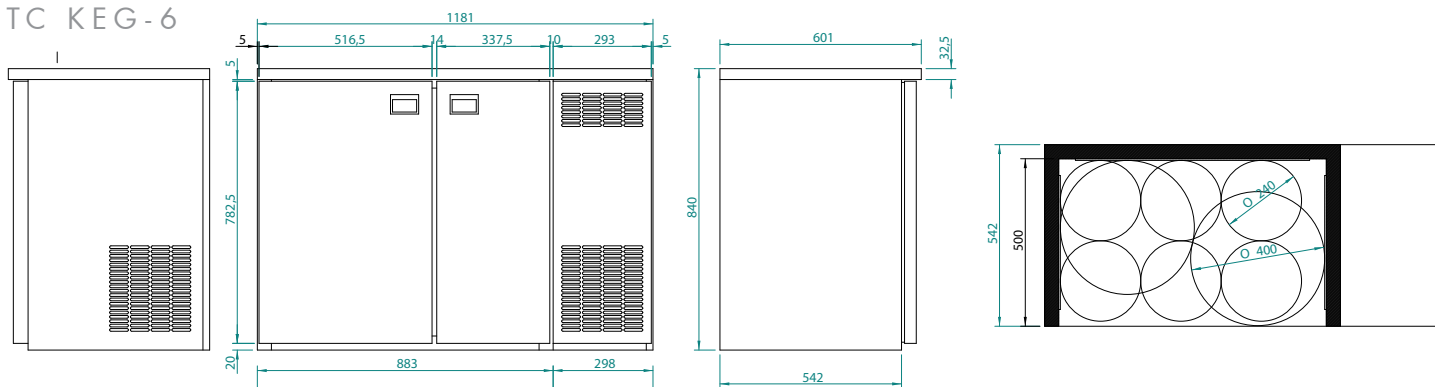

TC KEG-8

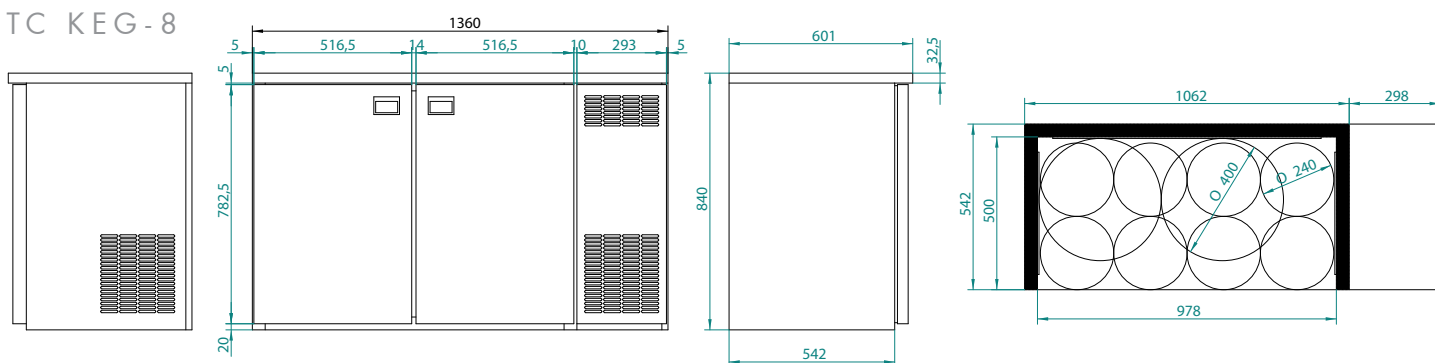

**THERMOTECHNIKA KERESKEDELMI KFT.**

BUDAPEST SHOWROOM AND HEADQUARTERS: H-1103 BUDAPEST, KŐÉR U. 3/F  
TELEFON: (+36-1) 260-7126, 260-7082 • FAX: (+36-1) 433-3851

[thermotechnika@tcbungary.com](mailto:thermotechnika@tcbungary.com)

[www.tcbungary.com](http://www.tcbungary.com)



THERMOTECHNIKA  
CROWN COOL  
EUROPEAN ECONOMIC INTEREST GROUP